

IPSO CLAUDIT

SISTEMI DIGA SAEPTUM E REDUCTA / SAEPTUM & REDUCTA DAN SYSTEM

IPSO CLAUDIT sistemi per il fissaggio e la finitura della zona a pavimento dei box doccia scorrevoli serie IPC
Due differenti soluzioni sono disponibili:

-SAEPTUM con vetro fisso inserito in profilo diga continuo
IPD01 + profilo cover a scatto IPC03

-REDUCTA con vetro fisso a filo piatto doccia, barriera ridotta
IPD02, accessorio porta guida a pavimento IPD03, fermavetro
IPD04, giunto angolare IPD05

IPSO CLAUDIT water containment and floor area finishing
systems for IPC series shower rooms
Two different solutions are available:

-SAEPTUM with fixed glass inserted into IPD01 floor dam
profile + IPC03 clicking closing profile

-REDUCTA with fixed glass flush mounting, IPD02 low profile
floor dam, IPD03 guide holder, IPD04 glass holder, IPD05
corner joint



SAEPTUM



REDUCTA

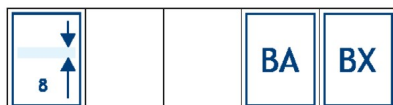

IPD01

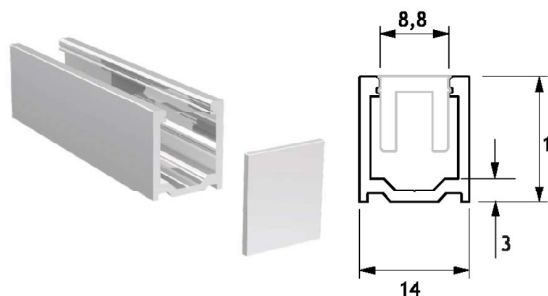

Canalina di contenimento acqua e/o per fissaggio a pavimento del vetro laterale per sistemi IPC, RS, RSZ e MS
Estruso in lega di alluminio
Lunghezza delle barre mm 1500-2200

«U» profile floor dam and/or floor fixing of the side glass
For IPC, RS, RSZ e MS systems
Extruded aluminium alloy
Bar length: 1500-2200 mm

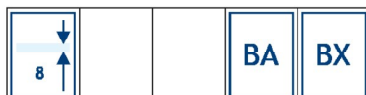

IPC03

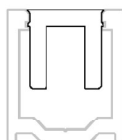
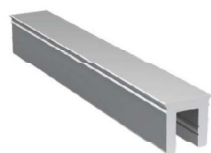

IPSO CLAUDIT SAEPTUM profilo chiusura a scatto per IPC01 e IPD01
Si utilizza per chiudere e rifinire la canalina IPD01
Estruso in lega di alluminio
Lunghezza delle barre mm 1500-2200

IPSO CLAUDIT SAEPTUM clicking closing profile for IPC01 and IPD01
It is used to close and finish the slots of the fixed glass
Extruded aluminium alloy
Bar length: 1500-2200 mm

			BA	BX
--	--	--	----	----

SAE-145/SAE-220



IPSO CLAUDIT kit profili SAEPTUM per cabine doccia a un'anta disponibile in due misure e costituito da: 1 pz IPD01
La guida a pavimento e gli elementi da applicare sulla testa del profilo sono già compresi nei kit IPCS01 e IPCS02. Il profilo di chiusura IPC03 è già compreso nei kit profili di scorrimento
Estruso in lega di alluminio
Lunghezza della barra mm 1500 e 2200 a seconda del kit

IPSO CLAUDIT SAEPTUM profiles set for single door shower rooms available in two sizes and composed of: 1 pc IPD01
Floor guide and bar end finishing elements are included in IPCS01 and IPCS02 sets
IPC03 clicking closing profile is included in the rail sets
Extruded aluminium alloy
Bar length: 1500 and 2200 mm according to the set

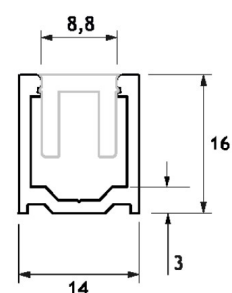

SAE90

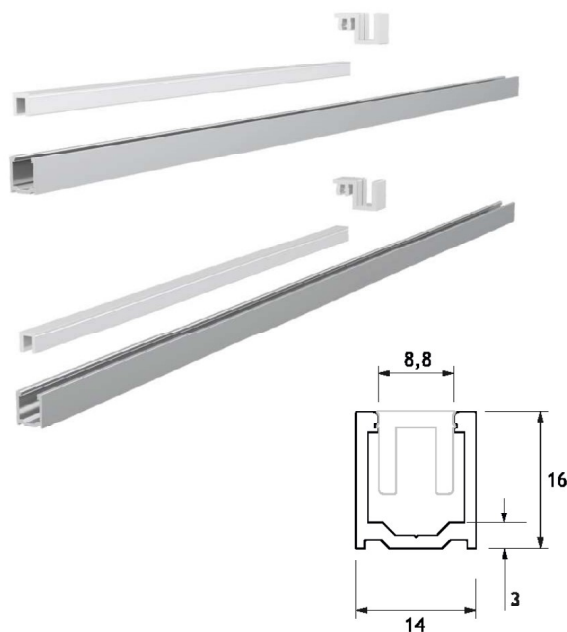

IPSO CLAUDIT kit profili SAEPTUM per cabine doccia a doppia anta a 90° costituito da:
1 pz IPD01. Le guide a pavimento sono già comprese nel kit IPCS01
Il profilo di chiusura IPC03 è già compreso nei kit profili di scorrimento
Estruso in lega di alluminio
Lunghezza della barra mm 2200

IPSO CLAUDIT SAEPTUM profiles set for 90° double door shower rooms available in one size and composed of: 1 pc IPD01
Floor guides are included in IPCS01 set
IPC03 clicking closing profile is included in the rail sets
Extruded aluminium alloy
Bar length: 2200 mm

↓ 8 ↑	MIN 840	MAX 1100	BA	BX
-------------	------------	-------------	----	----